

Kanlux

A man with a beard and glasses, wearing a blue long-sleeved shirt and a purple and white scarf, is leaning over a table. He is holding a pencil and looking towards the camera. A woman with glasses and her hair in a bun is leaning over the table, looking down at a piece of blue fabric. They are in a workshop or studio with large windows in the background. A roll of brown paper is visible in the foreground on the left. A black LED light fixture is mounted on the ceiling.

KANLUX HIERRO LED

Professzionális lámpatest család, amely ötvözi a design, a funkcionalitást és az esztétikát.

Kanlux

FACTORY

Kanlux

Kanlux HIERRO LED



**Professzionális
felhasználásra tervezve**

A kiváló világítási paramétereknek köszönhetően a Kanlux HIERRO LED lámpatestek energiatakarékos és korszerű világítási rendszerek létrehozását teszik lehetővé. Nem mindennapi kinézetük révén vonzó vizuális hatást biztosítanak.

A termékre vonatkozó információkat a **rendelkezésre álló vezérlési módszerek** teszik teljessé, amelyek lehetővé teszik az intelligens világításvezérlést bármely létesítményben.



low
UGR

5 ÉV GARANCIA A WEBOLDALON ELÉRHETŐ
GARANCIÁLIS NYILATKOZAT FELTÉTELEI SZERINT

Kanlux

Kanlux FACTORY HIERRO LED

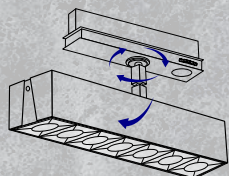

HR-RMFX
sínre szerelhető változat
FLEX 340° / 90° (opcionális)

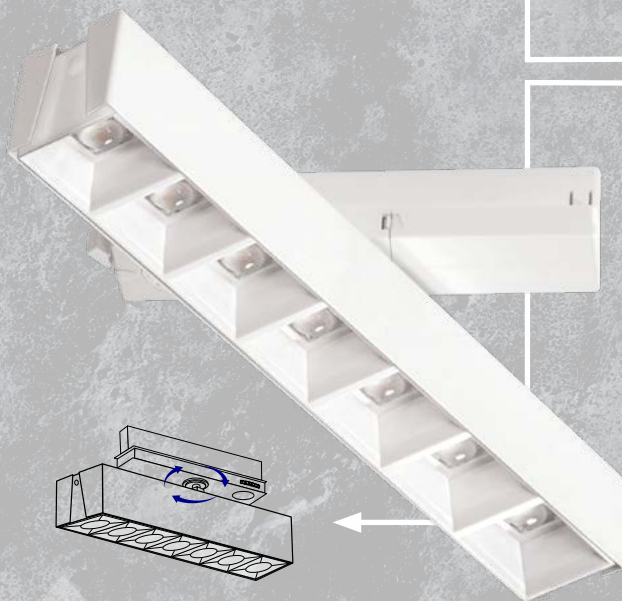

HR-RM
sínre szerelhető változat
ALAP VERZIÓ 340°

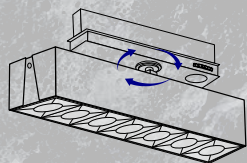

HR-PT
süllyesztett változat

HR-PT

süllyesztett változat

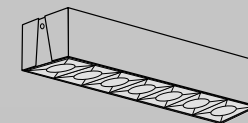

HR-NT
faln kívüli változat

HR-NT

faln kívüli változat

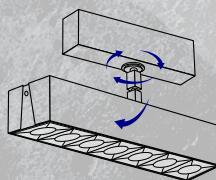

HR-NTFX
faln kívüli változat FLEX
340° / 90° (opcionális)

HR-NTFX

faln kívüli változat FLEX
340° / 90° (opcionális)

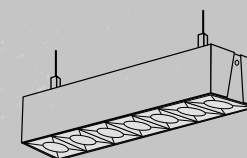

HR-NT
faln kívüli változat
függesztett

HR-NT

faln kívüli változat
függesztett



Kanlux

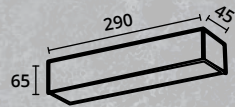

HR-S

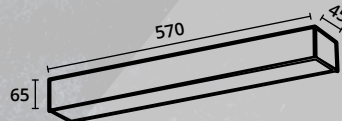

HR-M

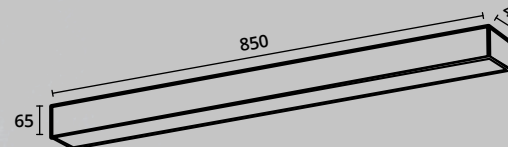

HR-L

3-FÉLE HOSSZÚSÁG

2-FÉLE OPTIKA



világítási szög



egyéni rendelésre

HIERRO LED

4-FÉLE SZÍNHŐMÉRSÉKLET

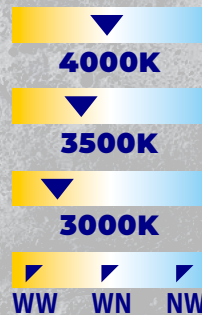

3-FÉLE LÁMPAHÁZ SZÍN



fehér



fekete



fehér/fekete



Kanlux

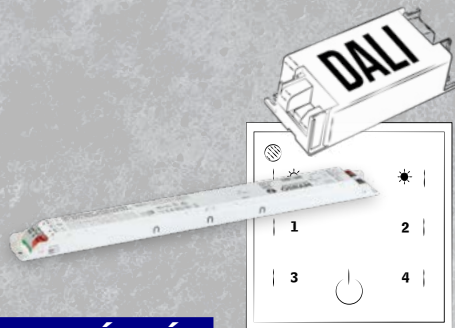

**OPCIONÁLIS DALI VEZÉRLÉS
ÉS CASAMBY READY OPCIO**



HIERRO LED



**A KÁPRÁZÁST CSÖKKENTŐ
ÚJ GENERÁCIÓS SZERKEZET**

**MÁRKÁS DIÓDÁK ÉS
MŰKÖDTETŐK**



Kanlux

Kanlux HIERRO LED

HR-NT

DALI
VEZÉRLÉSEL ELLÁTOTT
VÁLTOZATBAN IS

- ① falon kívüli változat
- ② FLEX falon kívüli változat (opcionális)
- ③ függesztett változat

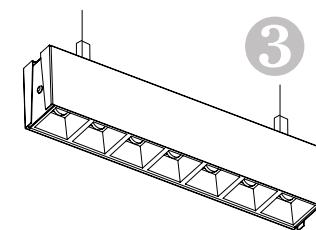
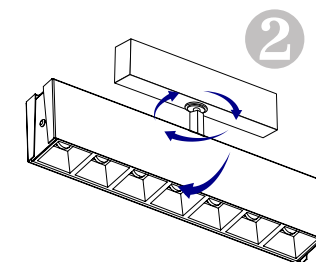
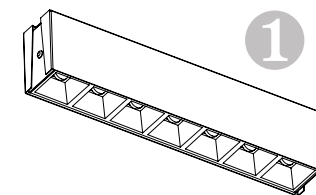

NÉZZE MEG
A TELJES
KÍNÁLATOT

Kanlux

Kanlux HIERRO LED

HR-PT

DALI
VEZÉRLÉSEL ELLÁTOTT
VÁLTOZATBAN IS

① süllyesztett változat

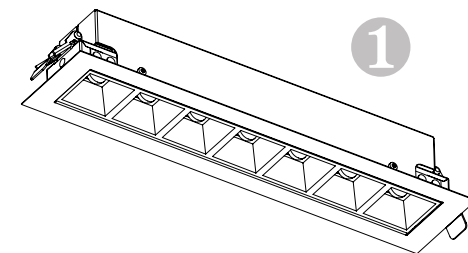

NÉZZE MEG
A TELJES
KÍNÁLATOT

Kanlux

Kanlux HIERRO LED

HR-RM

- ① sínre szerelhető változat
ALAP VERZIÓ 340°
- ② sínre szerelhető változat
FLEX 340° / 90° (opcionális)

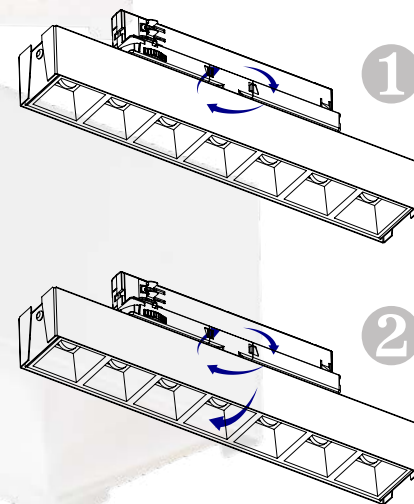

NÉZZE MEG
A TELJES
KÍNÁLATOT

Kanlux

Válassza ki a megfelelő **HIERRO LED** lámpatestet

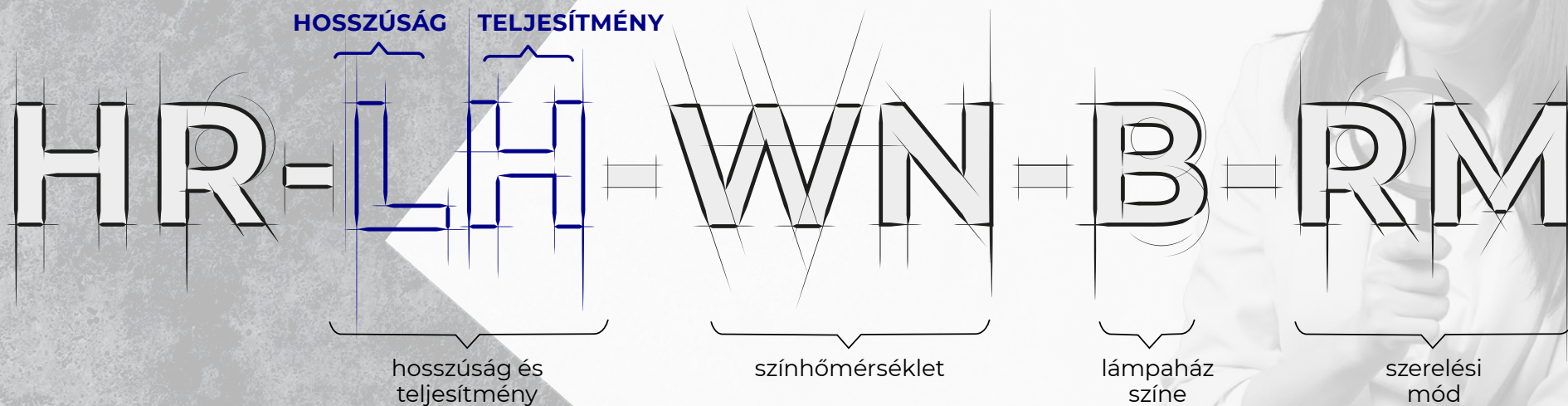

HR	HIERRO LED
HRD	HIERRO LED DALI
HRC	HIERRO LED CASAMBI READY

WW/830	Ra≥80 3000K
WN/835	Ra≥80 3500K
NW/840	Ra≥80 4000K
TW	TUNABLE WHITE (hangolható fehér) változat

W	lámpaház színe: fehér
B	lámpaház színe: fekete

NT	falon kívüli változat
PT	süllyesztett változat
HIERRO +ALIN CORD +ROPE	függesztett változat
RM	sínre szerelhető változat

LÁMPATEST FÉNYÁRAMA

	TELJESÍTMÉNY	WW		WN		NW	
		FEHÉR	FEKETE	FEHÉR	FEKETE	FEHÉR	FEKETE
SL	9W	1150lm	1050lm	1200lm	1050lm	1250lm	1100lm
SH	14W	1650lm	1450lm	1700lm	1500lm	1700lm	1550lm
ML	18W	2350lm	2100lm	2400lm	2150lm	2450lm	2200lm
MM	23W	2850lm	2500lm	2900lm	2600lm	3000lm	2650lm
MH	28W	3300lm	2900lm	3350lm	3000lm	3450lm	3050lm
LL	23W	3000lm	2650lm	3050lm	2700lm	3150lm	2800lm
LM	32W	4000lm	3550lm	4100lm	3650lm	4200lm	3750lm
LH	42W	4950lm	4350lm	5050lm	4500lm	5150lm	4600lm

		VERZIÓ		
	HOSSZÚSÁG	NT	PT	RM
S	HOSSZÚSÁG	290mm	315mm	290mm
M	HOSSZÚSÁG	570mm	595mm	570mm
L	HOSSZÚSÁG	850mm	875mm	850mm



FEHÉR	36940	HR-SL-WW-W-NT	1150lm	9W 3000K
	36941	HR-SH-WW-W-NT	1650lm	14W 3000K
	36956	HR-SL-WN-W-NT	1200lm	9W 3500K
	36957	HR-SH-WN-W-NT	1700lm	14W 3500K
	36972	HR-SL-NW-W-NT	1250lm	9W 4000K
FEKETE	36973	HR-SH-NW-W-NT	1700lm	14W 4000K
	36948	HR-SL-WW-B-NT	1050lm	9W 3000K
	36949	HR-SH-WW-B-NT	1450lm	14W 3000K
	36964	HR-SL-WN-B-NT	1050lm	9W 3500K
	36965	HR-SH-WN-B-NT	1500lm	14W 3500K
FEHÉR	36980	HR-SL-NW-B-NT	1100lm	9W 4000K
	36981	HR-SH-NW-B-NT	1550lm	14W 4000K
	36942	HR-ML-WW-W-NT	2350lm	18W 3000K
	36943	HR-MM-WW-W-NT	2850lm	23W 3000K
	36944	HR-MH-WW-W-NT	3300lm	28W 3000K
FEKETE	36958	HR-ML-WN-W-NT	2450lm	18W 3500K
	36959	HR-MM-WN-W-NT	3000lm	23W 3500K
	36960	HR-MH-WN-W-NT	3450lm	28W 3500K
	36974	HR-ML-NW-W-NT	2150lm	18W 4000K
	36975	HR-MM-NW-W-NT	2600lm	23W 4000K
FEKETE	36976	HR-MH-NW-W-NT	3000lm	28W 4000K
	36966	HR-ML-WW-B-NT	2100lm	18W 3000K
	36967	HR-MM-WW-B-NT	2500lm	23W 3000K
	36968	HR-MH-WW-B-NT	2900lm	28W 3000K
	36950	HR-ML-WN-B-NT	2400lm	18W 3500K
FEHÉR	36951	HR-MM-WN-B-NT	2900lm	23W 3500K
	36952	HR-MH-WN-B-NT	3350lm	28W 3500K
	36982	HR-ML-NW-B-NT	2200lm	18W 4000K
	36983	HR-MM-NW-B-NT	2650lm	23W 4000K
	36984	HR-MH-NW-B-NT	3050lm	28W 4000K
FEKETE	36945	HR-LL-WW-W-NT	3000lm	23W 3000K
	36946	HR-LM-WW-W-NT	4000lm	32W 3000K
	36947	HR-LH-WW-W-NT	4950lm	42W 3000K
	36977	HR-LL-WN-W-NT	2700lm	23W 3500K
	36978	HR-LM-WN-W-NT	3650lm	32W 3500K
FEHÉR	36979	HR-LH-WN-W-NT	4500lm	42W 3500K
	36961	HR-LL-NW-W-NT	3150lm	23W 4000K
	36962	HR-LM-NW-W-NT	4200lm	32W 4000K
	36963	HR-LH-NW-W-NT	5150lm	42W 4000K
	36969	HR-LL-WW-B-NT	2650lm	23W 3000K
FEKETE	36970	HR-LM-WW-B-NT	3550lm	32W 3000K
	36971	HR-LH-WW-B-NT	4350lm	42W 3000K
	36953	HR-LL-WN-B-NT	3050lm	23W 3500K
	36954	HR-LM-WN-B-NT	4100lm	32W 3500K
	36955	HR-LH-WN-B-NT	5050lm	42W 3500K
FEKETE	36985	HR-LL-NW-B-NT	2800lm	23W 4000K
	36986	HR-LM-NW-B-NT	3750lm	32W 4000K
	36987	HR-LH-NW-B-NT	4600lm	42W 4000K

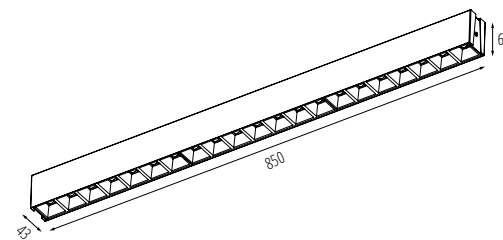
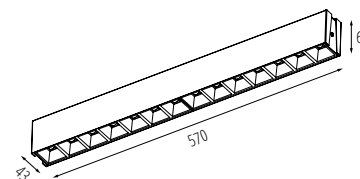
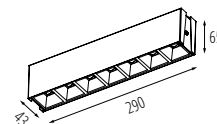

DALI
VEZÉRLÉSEL ELLÁTOTT
VÁLTOZAT



FEHÉR	36988	HRD-ML-WW-W-NT	2350lm	18W	3000K
	36989	HRD-MM-WW-W-NT	2850lm	23W	3000K
	36990	HRD-MH-WW-W-NT	3300lm	28W	3000K
	37012	HRD-ML-WN-W-NT	2150lm	18W	3500K
	37013	HRD-MM-WN-W-NT	2600lm	23W	3500K
	37014	HRD-MH-WN-W-NT	3000lm	28W	3500K
	37000	HRD-ML-NW-W-NT	2450lm	18W	4000K
	37001	HRD-MM-NW-W-NT	3000lm	23W	4000K
	37002	HRD-MH-NW-W-NT	3450lm	28W	4000K
	FEKETE	37006	HRD-ML-WN-B-NT	2100lm	18W
37007		HRD-MM-WN-B-NT	2500lm	23W	3000K
37008		HRD-MH-WN-B-NT	2900lm	28W	3000K
36994		HRD-ML-WW-B-NT	2400lm	18W	3500K
36995		HRD-MM-WW-B-NT	2900lm	23W	3500K
36996		HRD-MH-WW-B-NT	3350lm	28W	3500K
37018		HRD-ML-NW-B-NT	2200lm	18W	4000K
37019		HRD-MM-NW-B-NT	2650lm	23W	4000K
37020		HRD-MH-NW-B-NT	3050lm	28W	4000K
FEHÉR		36991	HRD-LL-WW-W-NT	3000lm	23W
	36992	HRD-LM-WW-W-NT	4000lm	32W	3000K
	36993	HRD-LH-WW-W-NT	4950lm	42W	3000K
	37003	HRD-LL-WN-W-NT	3150lm	23W	3500K
	37004	HRD-LM-WN-W-NT	4200lm	32W	3500K
	37005	HRD-LH-WN-W-NT	5150lm	42W	3500K
	37015	HRD-LL-NW-W-NT	2700lm	23W	4000K
	37016	HRD-LM-NW-W-NT	3650lm	32W	4000K
	37017	HRD-LH-NW-W-NT	4500lm	42W	4000K
	FEKETE	36997	HRD-LL-WW-B-NT	3050lm	23W
36998		HRD-LM-WW-B-NT	4100lm	32W	3500K
36999		HRD-LH-WW-B-NT	5050lm	42W	3500K
37009		HRD-LL-WN-B-NT	2650lm	23W	3500K
37010		HRD-LM-WN-B-NT	3550lm	32W	3500K
37011		HRD-LH-WN-B-NT	4350lm	42W	3500K
37021		HRD-LL-NW-B-NT	2800lm	23W	4000K
37022		HRD-LM-NW-B-NT	3750lm	32W	4000K
37023		HRD-LH-NW-B-NT	4600lm	42W	4000K

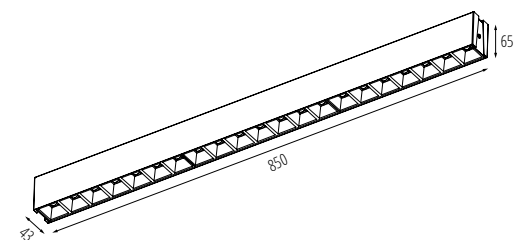
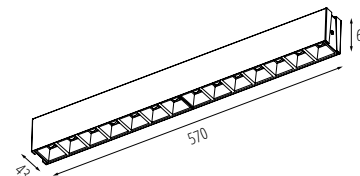

Kanlux HIERRO LED KIEGÉSZÍTŐK



FEHÉR	32540	ALIN CORD 1F-W	
	32543	ALIN CORD DALI 1F-W	
FEKETE	32541	ALIN CORD 1F-B	
	32544	ALIN CORD DALI 1F-B	



07871
ROPE-NT 150 SINGLE

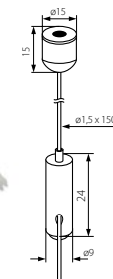



FEHÉR	37024	HR-SL-WW-W-PT	1150lm	9W	3000K
	37025	HR-SH-WW-W-PT	1650lm	14W	3000K
	37040	HR-SL-WN-W-PT	1200lm	9W	3500K
	37041	HR-SH-WN-W-PT	1700lm	14W	3500K
	37056	HR-SL-NW-W-PT	1250lm	9W	4000K
FEKETE	37057	HR-SH-NW-W-PT	1700lm	14W	4000K
	37032	HR-SL-WW-B-PT	1050lm	9W	3000K
	37033	HR-SH-WW-B-PT	1450lm	14W	3000K
	37048	HR-SL-WN-B-PT	1050lm	9W	3500K
	37049	HR-SH-WN-B-PT	1500lm	14W	3500K
FEHÉR	37064	HR-SL-NW-B-PT	1100lm	9W	4000K
	37065	HR-SH-NW-B-PT	1550lm	14W	4000K
	37026	HR-ML-WW-W-PT	2350lm	18W	3000K
	37027	HR-MM-WW-W-PT	2850lm	23W	3000K
	37028	HR-MH-WW-W-PT	3300lm	28W	3000K
FEHÉR	37042	HR-ML-WN-W-PT	2400lm	18W	3500K
	37043	HR-MM-WN-W-PT	2900lm	23W	3500K
	37044	HR-MH-WN-W-PT	3350lm	28W	3500K
	37058	HR-ML-NW-W-PT	2450lm	18W	4000K
	37059	HR-MM-NW-W-PT	3000lm	23W	4000K
FEKETE	37060	HR-MH-NW-W-PT	3450lm	28W	4000K
	37034	HR-ML-WW-B-PT	2100lm	18W	3000K
	37035	HR-MM-WW-B-PT	2500lm	23W	3000K
	37036	HR-MH-WW-B-PT	2900lm	28W	3000K
	37050	HR-ML-WN-B-PT	2150lm	18W	3500K
FEKETE	37051	HR-MM-WN-B-PT	2600lm	23W	3500K
	37052	HR-MH-WN-B-PT	3000lm	28W	3500K
	37066	HR-ML-NW-B-PT	2200lm	18W	4000K
	37067	HR-MM-NW-B-PT	2650lm	23W	4000K
	37068	HR-MH-NW-B-PT	3050lm	28W	4000K
FEHÉR	37029	HR-LL-WW-W-PT	3000lm	23W	3000K
	37030	HR-LM-WW-W-PT	4000lm	32W	3000K
	37031	HR-LH-WW-W-PT	4950lm	42W	3000K
	37045	HR-LL-WN-W-PT	3050lm	23W	3500K
	37046	HR-LM-WN-W-PT	4100lm	32W	3500K
FEHÉR	37047	HR-LH-WN-W-PT	5050lm	42W	3500K
	37061	HR-LL-NW-W-PT	3150lm	23W	4000K
	37062	HR-LM-NW-W-PT	4200lm	32W	4000K
	37063	HR-LH-NW-W-PT	5150lm	42W	4000K
	FEKETE	37037	HR-LL-WW-B-PT	2650lm	23W
37038		HR-LM-WW-B-PT	3550lm	32W	3000K
37039		HR-LH-WW-B-PT	4350lm	42W	3000K
37053		HR-LL-WN-B-PT	2700lm	23W	3500K
37054		HR-LM-WN-B-PT	3650lm	32W	3500K
FEKETE	37055	HR-LH-WN-B-PT	4500lm	42W	3500K
	37069	HR-LL-NW-B-PT	2800lm	23W	4000K
	37070	HR-LM-NW-B-PT	3750lm	32W	4000K
	37071	HR-LH-NW-B-PT	4600lm	42W	4000K

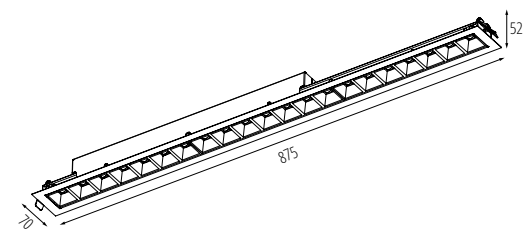
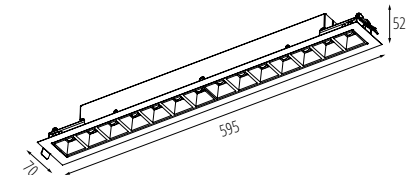
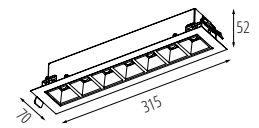

DALI
VEZÉRLÉSEL ELLÁTOTT
VÁLTOZAT

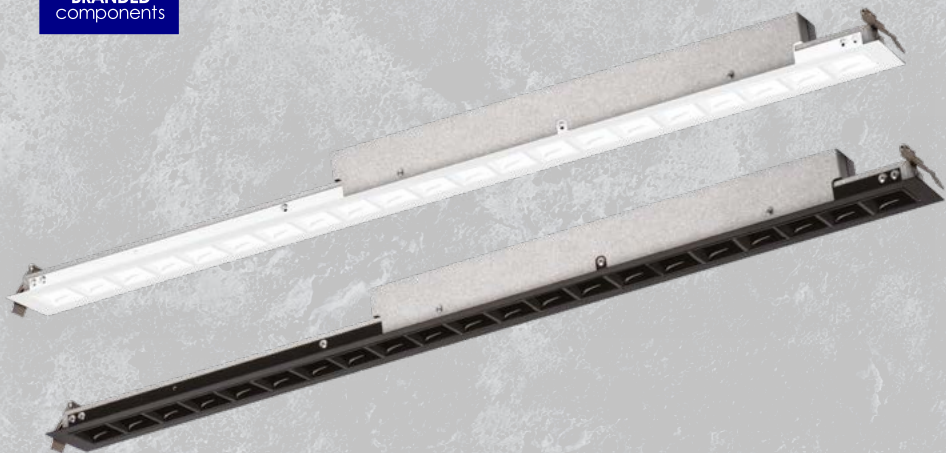

FEHÉR	37072	HRD-ML-WW-W-PT	2350lm	18W 3000K
	37073	HRD-MM-WW-W-PT	2850lm	23W 3000K
	37074	HRD-MH-WW-W-PT	3300lm	28W 3000K
	37084	HRD-ML-WN-W-PT	2400lm	18W 3500K
	37085	HRD-MM-WN-W-PT	2900lm	23W 3500K
	37086	HRD-MH-WN-W-PT	3350lm	28W 3500K
	37096	HRD-ML-NW-W-PT	2450lm	18W 4000K
	37097	HRD-MM-NW-W-PT	3000lm	23W 4000K
	37098	HRD-MH-NW-W-PT	3450lm	28W 4000K
FEKETE	37078	HRD-ML-WW-B-PT	2100lm	18W 3000K
	37079	HRD-MM-WW-B-PT	2500lm	23W 3000K
	37080	HRD-MH-WW-B-PT	2900lm	28W 3000K
	37090	HRD-ML-WN-B-PT	2150lm	18W 3500K
	37091	HRD-MM-WN-B-PT	2600lm	23W 3500K
	37092	HRD-MH-WN-B-PT	3000lm	28W 3500K
	37102	HRD-ML-NW-B-PT	2200lm	18W 4000K
	37103	HRD-MM-NW-B-PT	2650lm	23W 4000K
	37104	HRD-MH-NW-B-PT	3050lm	28W 4000K
FEHÉR	37075	HRD-LL-WW-W-PT	3000lm	23W 3000K
	37076	HRD-LM-WW-W-PT	4000lm	32W 3000K
	37077	HRD-LH-WW-W-PT	4950lm	42W 3000K
	37087	HRD-LL-WN-W-PT	3050lm	23W 3500K
	37088	HRD-LM-WN-W-PT	4100lm	32W 3500K
	37089	HRD-LH-WN-W-PT	5050lm	42W 3500K
	37099	HRD-LL-NW-W-PT	3150lm	23W 4000K
	37100	HRD-LM-NW-W-PT	4200lm	32W 4000K
	37101	HRD-LH-NW-W-PT	5150lm	42W 4000K
FEKETE	37081	HRD-LL-WW-B-PT	2650lm	23W 3000K
	37082	HRD-LM-WW-B-PT	3550lm	32W 3000K
	37083	HRD-LH-WW-B-PT	4350lm	42W 3000K
	37093	HRD-LL-WN-B-PT	2700lm	23W 3500K
	37094	HRD-LM-WN-B-PT	3650lm	32W 3500K
	37095	HRD-LH-WN-B-PT	4500lm	42W 3500K
	37105	HRD-LL-NW-B-PT	2800lm	23W 4000K
37106	HRD-LM-NW-B-PT	3750lm	32W 4000K	
37107	HRD-LH-NW-B-PT	4600lm	42W 4000K	

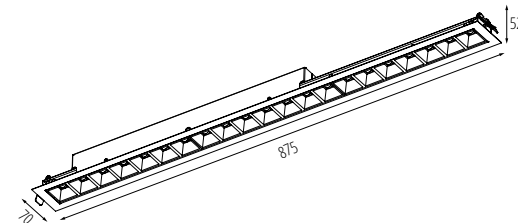
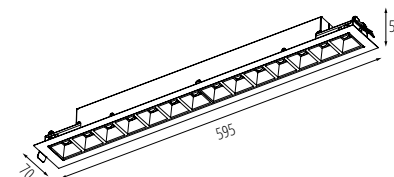



FEHÉR	37108	HR-SL-WW-W-RM	1150lm	9W 3000K
	37109	HR-SH-WW-W-RM	1650lm	14W 3000K
	37122	HR-SL-WN-W-RM	1200lm	9W 3500K
	37123	HR-SH-WN-W-RM	1700lm	14W 3500K
	37136	HR-SL-NW-W-RM	1250lm	9W 4000K
FEKETE	37137	HR-SH-NW-W-RM	1700lm	14W 4000K
	37115	HR-SL-WW-B-RM	1050lm	9W 3000K
	37116	HR-SH-WW-B-RM	1450lm	14W 3000K
	37129	HR-SL-WN-B-RM	1050lm	9W 3500K
	37130	HR-SH-WN-B-RM	1500lm	14W 3500K
FEHÉR	37143	HR-SL-NW-B-RM	1100lm	9W 4000K
	37144	HR-SH-NW-B-RM	1550lm	14W 4000K
	37110	HR-MM-WW-W-RM	2850lm	23W 3000K
	37111	HR-MH-WW-W-RM	3300lm	28W 3000K
	37124	HR-MM-WN-W-RM	2900lm	23W 3000K
FEKETE	37125	HR-MH-WN-W-RM	3350lm	28W 3500K
	37138	HR-MM-NW-W-RM	2900lm	23W 3500K
	37139	HR-MH-NW-W-RM	3350lm	28W 3500K
	37117	HR-MM-WW-B-RM	2500lm	23W 3000K
	37118	HR-MH-WW-B-RM	2900lm	28W 3000K
FEHÉR	37131	HR-MM-WN-B-RM	2600lm	23W 3000K
	37132	HR-MH-WN-B-RM	3000lm	28W 4000K
	37145	HR-MM-NW-B-RM	2650lm	23W 4000K
	37146	HR-MH-NW-B-RM	3050lm	28W 4000K
	FEHÉR	37112	HR-LL-WW-W-RM	3000lm
37113		HR-LM-WW-W-RM	4000lm	32W 3000K
37114		HR-LH-WW-W-RM	4950lm	42W 3000K
37126		HR-LL-WN-W-RM	3050lm	23W 3500K
37127		HR-LM-WN-W-RM	4100lm	32W 3500K
FEKETE	37128	HR-LH-WN-W-RM	5050lm	42W 3500K
	37140	HR-LL-NW-W-RM	3150lm	23W 4000K
	37141	HR-LM-NW-W-RM	4200lm	32W 4000K
	37142	HR-LH-NW-W-RM	5150lm	42W 4000K
	FEKETE	37119	HR-LL-WW-B-RM	2650lm
37120		HR-LM-WW-B-RM	3550lm	32W 3000K
37121		HR-LH-WW-B-RM	4350lm	42W 3000K
37133		HR-LL-WN-B-RM	2700lm	23W 3500K
37134		HR-LM-WN-B-RM	3650lm	32W 3500K
FEKETE	37135	HR-LH-WN-B-RM	4500lm	42W 3500K
	37147	HR-LL-NW-B-RM	2800lm	23W 4000K
	37148	HR-LM-NW-B-RM	3750lm	32W 4000K
	37149	HR-LH-NW-B-RM	4600lm	42W 4000K

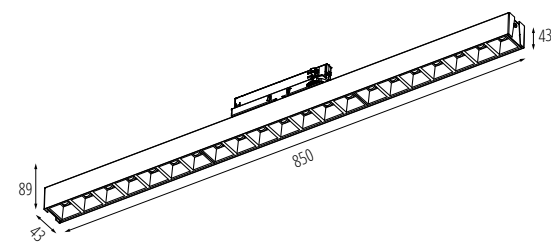
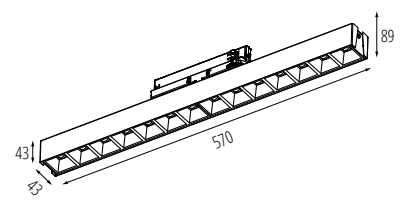
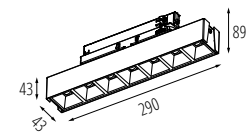

Kanlux



Kanlux HIERRO LED

Sokoldalú felhasználás
a széles termékválasztéknak
köszönhetően.
Még a legigényesebb
belső terekhez is.

Kanlux

Kanlux HIERRO LED

Irodák, lakások, éttermek,
szállodák, társasági terek.
Korlátok nélkül. Még a legnehezebb
projektek sem okoznak problémát.